

Cable management

For HYC_150

Key features

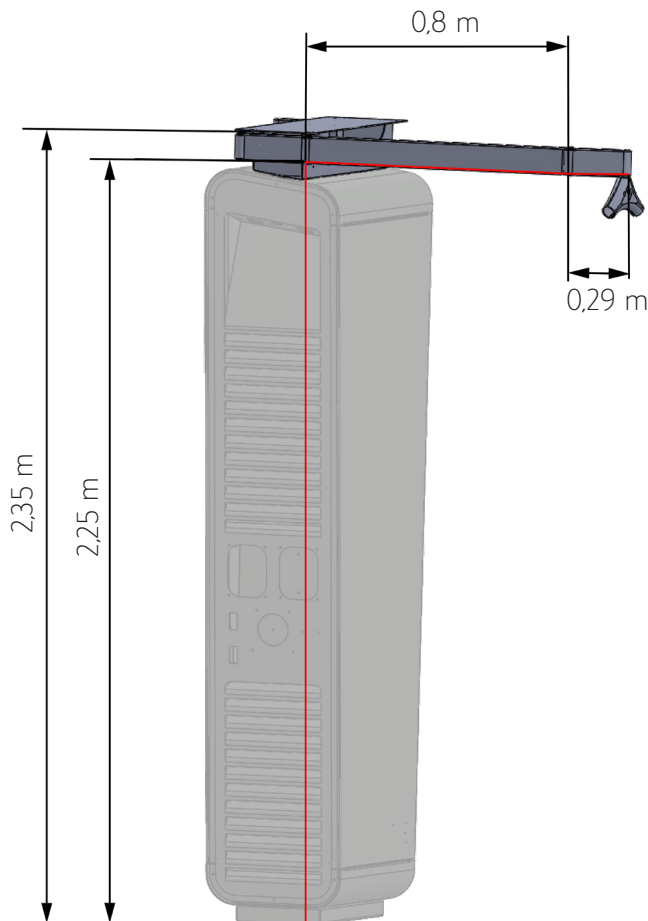

- Easier handling of the charging cables
- Charging cables no longer touch the ground while moving => longer lifespan
- 5 m cables
- With one or two arms
- Covers a large area - up to 4 m
- Weight ca. 26 kg

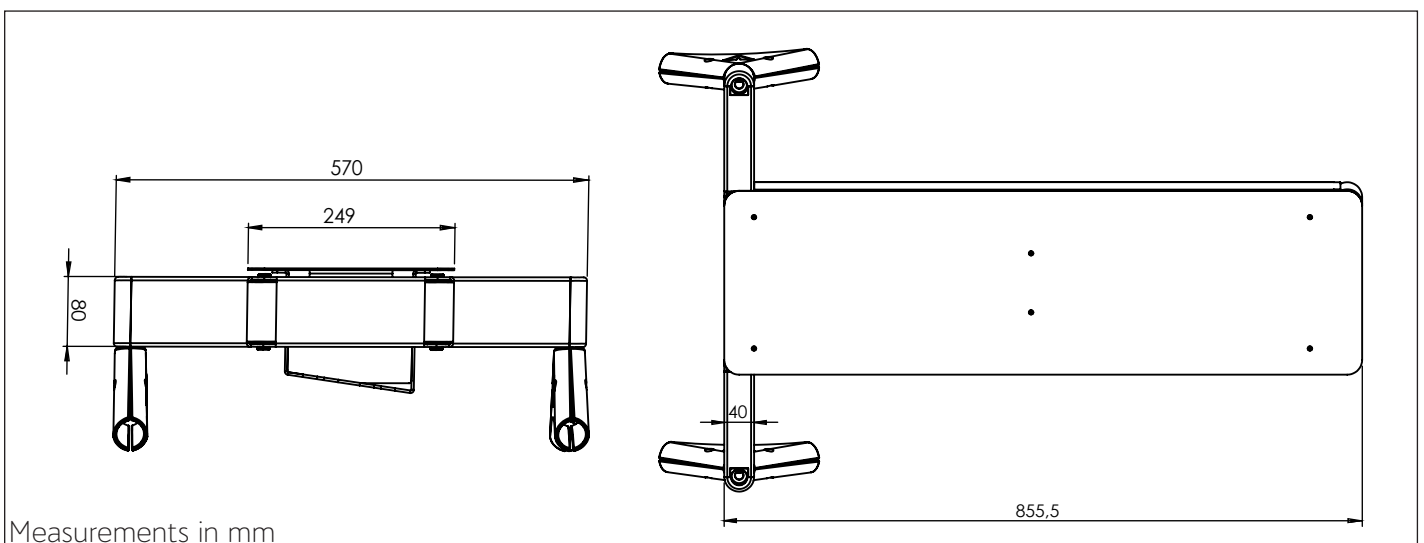

Measurements in mm

product brief cable management

© 2021 alpitronic GmbH
Via di Mezzo ai Piani, 33
39100 Bolzano BZ, Italy

info@hypercharger.it
www.hypercharger.it
Tel.: +39 0471 096 450

Cable management

For HYC_150

Maximum range

